

INSTRUCTION MANUAL

PNEUMATIC HACKSAW

Please read this manual carefully before you attempt to use your tool so that you may use it properly and safely.

SUPER SAW

Model SSW-110

PROFESSIONAL TOOL



Specifications

Model	SSW-110
Maximum Operating Pressure	0.6 MPa
Air Consumption (No Load)	0.29 m ³ /min
Stroke Speed (No Load)	7000 min ⁻¹
Stroke Length	11 mm
Mass (Weight)	0.62 kg
Sound Pressure Level	71 dB(A)
Sound Power Level	82 dB(A)
Vibration Level [Uncertainty K]	9.3 m/s ² [2.7 m/s ²]
Thread Size of Air Inlet	Rc1/4

Due to continuous product development/improvement the specifications and configurations in this document are subject to change without prior notice.



Manufactured by :

NITTO KOHKI Co., Ltd.

2-9-4, Nakaikegami, Ohta-ku,
Tokyo, 146-8555, Japan

Tel : (81)-3-3755-1111

Fax : (81)-3-3753-8791

E-mail : overseas@nitto-kohki.co.jp

URL : www.nitto-kohki.co.jp

Keep the manual handy – so you can use it whenever necessary.

Original Instructions

Thank you very much for your purchase of this **Nitto Kohki products.**





Before using your tool, please read this manual carefully so that you may use it properly to get the most out of it.

Please keep the manual handy - so you can use it whenever necessary.



- **English** : Please ask your dealer or distributor for instruction manual in local language(s).
- **German** : Bitte fragen Sie Ihren Händler nach eine Betriebsanleitung in Landessprache.
- **French** : S'il vous plait, veuillez demandez á votre fournisseur de manuel instruction en langue locale.
- **Spanish** : Por favor, contacte con su distribuidor para el manual de instrucciones en español.
- **Portuguese** : Por favor pessa ao seo agente ou distribuidor o manual de instrucces ih linguagen local.
- **Italian** : Per Manuale Istruzioni in lingua locale Vi preghiamo di rivolgervi al rivenditore o distributore.
- **Dutch** : Vraag uw handelaar om een nederladstalige gebruiksaanwijzing.
- **Swedish** : Be er lokala Åtreförsäljare eller distributör om manualer pá svenska.
- **Danish** : Venligst henvend Dem til den danske distributør for instructions manualer.
- **Polish** : Proszę pytać swojego dealera lub dystrybutora o instrukcje obsługi w języku localnym.
- **中文** : 請向當地供應商或經銷商詢問中文使用說明書

CONTENTS	page
IMPORTANT SAFETY INSTRUCTIONS	2
GENERAL : TOOLS	2
GENERAL : PNEUMATIC TOOLS	3
INSTRUCTIONS FOR THIS TOOL	3
1. USAGE	4
2. CHECK THE CONTENTS OF THE PACKAGE	4
3. AIR SUPPLY	4
4. OPERATION.....	4
5. THREAD SIZE OF HOSE FITTING	5
6. OPTIONAL PARTS	5
7. ORDERING SERVICE PARTS	5
8. STORAGE	5
9. EXPLODED DIAGRAM : SSW-110	6

PICTOGRAM

-  Warning: It might be dangerous to operate the tool if the instructions supplied are not followed.
-  Using this tool improperly could result in serious injury. Read the instruction manual before using.
-  Always wear suitable eye protection.
-  Always wear suitable hearing protection.
-  Always wear respiratory protective equipment (PPE).

The following Safety notations are used throughout the manual to highlight safety precautions for the user and for the tool.

 Warning:	Indicates a potentially hazardous situation which, if not avoided by following the instructions given, could result in death or serious injury.
 Caution:	Indicates a potentially hazardous situation which, if not avoided by following the instructions given, could result in injury or material damage.

Please note, however, that failure to observe safety precautions under the “ **Caution**” category could result in a serious occurrence depending on the situation: please observe all safety precautions in the manual.

Caution: Important precautions for tool setup, operation and maintenance.

IMPORTANT SAFETY INSTRUCTIONS

When using the tool, please observe the safety precautions below to prevent possible accident or injury.

GENERAL: TOOLS

Warning

TO OPERATORS

- **Wear proper clothing for the type of work being done.**
Take care so that clothing, ties, hair etc. will not become entangled with the moving parts. If items become entangled it will cause the operator to be pulled towards the tool and lead to possible cause of accident or injury.
- **Always wear suitable eye protection.**
Remember, regular glasses are not safety glasses. The lenses are only shock resistant, which will not give you sufficient eye protection you may need in your working environment.
- **Always wear suitable hearing protection.**
- **Wear respiratory protective equipment (PPE).**
Wear respiratory protective equipment (PPE) when working in an environment where dust particles are generated in operation.
- **Always wear suitable protective gloves.**
- **Avoid working posture that is too stressful.**
Always ensure a firm footing and well balanced posture.
- **Do not operate the tool if you are too tired.**
- **Never touch any moving parts of the tool when running.**

ABOUT WORK AREA

- **Keep the work area clean.**
Cluttered work areas (e.g. workbench) invite accidents.
- **Carefully select the work area.**
Do not expose tool to rain.
Do not use tool in a wet or soaked area.
See that the work area is adequately illuminated.
- **Never work near inflammable liquid or in a potentially explosive atmosphere.**
- **Keep children away from the work area.**
Keep children and unauthorized people away from the work area to avoid accident or injury.

BEFORE OPERATION

- **Inspect tool before use.**
Before using, check that screws are securely tightened, that any protective cover or guard is securely in place, other parts are free from damage and that the tool runs as it should.
Check that moving parts are properly adjusted for positioning and tightened, that parts are free from damage and properly mounted, and that all other parts are in good condition for normal operation.
Should you find any damage to the protective cover or other part, replace it in accordance with the Operation Manual. If there are no instructions in the Manual, please contact the sales agent through which you have purchased your tool or an authorized dealer near you for repair.
Likewise, if a switch failure occurs, contact sales agent through which you have purchased your tool or an authorized dealer near you for repair.
Do not use the tool if it does not start or stop with the start/stop switch.
 - **Securely mount cutter**
An improperly mounted cutter may fly out, causing possible damage to the tool or injury to the operator.
 - **Always remove spanner, wrench, etc., once adjustment has been made with them.**
 - **Use a tool appropriate for the application.**
Avoid heavy-duty application that is beyond the capacity of tool.
 - **Do not use the tool for purposes other than what it is designed for.**
 - **Do not abuse tool.**
Use tool in accordance with the specifications: you'll get the most out of it while ensuring safety.
 - **Securely fasten workpiece in place.**
Use a vice or clamp to securely fasten the workpiece in place. It is much safer this way than holding it in your hand, allowing you to operate the tool with both hands.
- #### ABOUT HANDLING
- **How to store tool.**
When the tool is not used, store it in a dry area and out of reach of children.
 - **How to carry tool.**
Do not touch the start switch while the tool is being carried.
 - **Do not leave the tool unattended while it is running.**
Turn off the start switch and disconnect the tool from power source. Do not leave the work area until the tool comes to a complete stop.

MAINTENANCE/SERVICE

- **Do not take apart or modify tool.**

Disassembly or modification carried out without the supervision of a qualified or authorized service engineer could result in an accident or injury.

- **Inspect cutting tool and accessories, etc.**

Always check to see that cutting tool and accessories, etc. are in good operating condition without damage or deterioration before you mount them on the tool. Should you find any damage to an accessory or part, please contact sales agent through which you have purchased your tool or an authorized dealer near you for repair.

- **Check parts for damage.**

When you have found damage to accessory or other part, carefully check the damaged part to determine the extent of influence it has upon the functions of the tool – that is, determine whether it can still perform its normal functions.

Check to see that the linkage of the moving parts is OK, that all parts are OK without damage, that they are properly mounted, and that the tool functions normally. Should you find any damage to an accessory or part that may hamper proper functioning of the tool, please contact sales agent through which you have purchased your tool or an authorized dealer near you for repair.

- **Have your tool repaired at an authorized Nitto Service Center.**

For repair or parts replacement, please contact the sales agent through which you have purchased your tool or an authorized dealer near you.

- **Use only Nitto genuine parts.**

Use of improper parts may result in serious occurrence.

To obtain a Nitto genuine part, consult this Manual or contact the sales agent from which you have purchased your tool directly.

- **Do not detach label or nameplate from tool.**

When a label/nameplate gets damaged, worn or becomes missing, contact the sales agent through which you have purchased your tool or Nitto Kohki Co. Ltd, directly for a replacement.

DISPOSAL

When a tool is taken permanently out of service, it is advised that the tool is disassembled, degreased and parts separated by material and recycled locally in the appropriate manner.

GENERAL: PNEUMATIC TOOLS

Warning

- **Use appropriate air pressure.**

Excessively high air pressure will increase the number of revolutions or strokes causing not only potential premature failure/breakage but could also lead to an unexpected accident or injury.

- **Connect tool to air supply line.**

There are various types of pipes running in a factory in addition to the pneumatic line (such as oxygen, nitrogen, gas and water). For this reason, always ensure that you are connecting to the pneumatic line.

- **Start tool properly.**

Turn the start switch OFF before connecting to the air supply line.

- **Always disconnect the tool from the air supply line before putting on/taking off any accessory and prior to carrying out any maintenance work.**

- **Avoid exposure to exhaust air.**

Pneumatic tool exhaust air contains oil and contaminated moisture. Make sure the exhaust air is not directed towards your face or anyone else within the work area.

- **Keep tool off electricity.**

This pneumatic tool is not electrically insulated. To avoid a potential electric shock do not use where there is a possibility of coming into contact with live electricity.

Caution

- **Handle tool carefully.**

Abusive use of tool could invite failure or accident. Do not throw, drop or shock the tool.

- **Handle air hose carefully.**

Do not carry the tool by the air hose. Do not pull the air hose to disconnect.

INSTRUCTIONS FOR THIS TOOL

About Your Tool

Warning

- **Wear protective glasses and a dustproof mask.**

Operation generates chips and dust particles, etc.

which may cause eye and/or respiratory injury: Always use PPE (Personal Protective Equipment) for eye and respiratory protection.

● **Wear vibration reducing and shock absorbing gloves.**

This is a power tool utilizing vibration. Wear vibration reducing and shock absorbing gloves. When your hands, fingers, arms, etc. feel discomfort during operations, immediately stop your work. Long hour operation should be prohibited, for it may cause vibration-induced disorder.

● **Use hearing protection gear.**

The tool generates loud noise. Always use ear plugs for hearing protection.

Take necessary measures to comply with the local regulatory requirements and laws with regard to noise level, or do better.

1. USAGE

This tool is for sawing workpieces using a Saw Blade.

2. CHECK THE CONTENTS OF THE PACKAGE

Check the contents and make sure that the tool does not have any damage which may have occurred during transportation. The contents should correspond to the list as follows. In case of damage/missing parts, please contact the sales agent from whom you purchased the tool.

Package Contents	Qty	Check
SUPER SAW SSW-110	1set	
Bushing R1/4xNPT1/4	1	
Saw Blade 32	1	
Hex. Socket Screw Key 3	1	
Instruction Manual	1	
Declaration of Conformity	1	
Caution for Use	1	

3. AIR SUPPLY

3-1. Air Pressure

Adjust air pressure with the air regulator to the level appropriate for the pneumatic tool used.

Air pressure that is too low will fails the tool to operate at full capacity.

Air pressure that is too high may cause damage to the tool.

3-2. Air Line (Fig.1)

Use a 9.5mm (3/8") I.D. connecting hose between the compressor and the tool.

Drained water, etc., if flown into the tool, could cause tool failure. Install an air filter. between the

compressor and the tool.

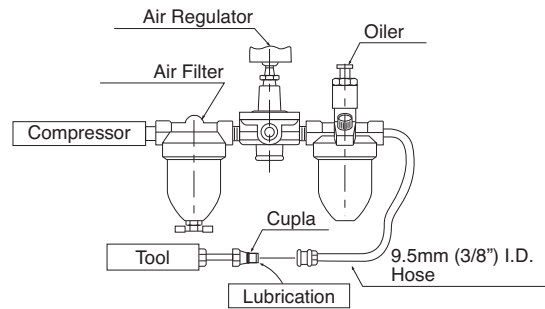

Fig. 1

3-3. Lubrication

Install an oiler between the compressor and the tool. Use the machine oil ISO VG-10. Failure to lubricate as required may result in damage to the tool. Use of oil that is too thick will reduce the performance of tool.

4. OPERATION

4-1. Mounting Saw Blade (Fig.2)

Warning

● **Always turn off the air supply and disconnect the air supply hose.**

Use Saw Blades with less than 90mm Blade length. Longer Blades may possibly cause personal injury due to inevitable unbalanced mounting.

Loosen Hex. Socket Set Screw 6x6 with Hex. Socket Screw Key 3. Insert the grip of a new Blade into the groove on Guide Shaft as far as it stops, and retighten the Screw with Hex. Socket Screw Key 3 until the Blade is firmly fixed.

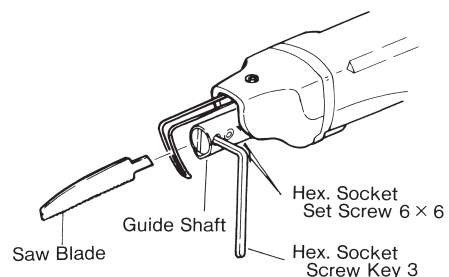

Fig.2

4-2. Start and Stop (Fig.3)

To start, release the Lock Lever and grasp the Throttle Lever.

To stop, release the Throttle Lever.

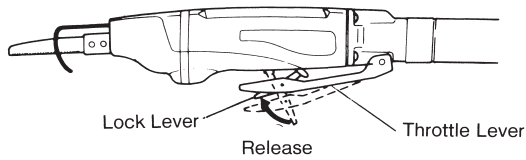

Fig.3

4-3. Adjust Valve (Fig.4)

⚠ Warning

- **Be sure to keep hands clear of moving parts.**
The desired number of speed between maximum and minimum speed is obtained by turning the groove of valve clockwise or counterclockwise with screwdriver.
- **Maximum speed**
Position the groove of Adjust Valve horizontal to main body.
- **Minimum speed**
Position the groove of Adjust Valve vertical to main body.

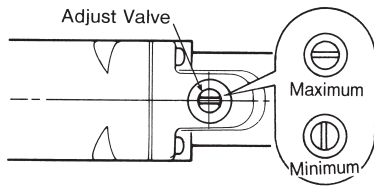

Fig.4

4-4. Operating Tips

- (1) Depress the tool gently onto the workpiece when cutting. Do not depress the tool onto the workpiece too hard, because the stroke is shortened, the number of strokes is reduced and the cutting capacity is lowered as a result.
- (2) Turn the Adjust Valve with screwdriver when doing minute work or when the power is excessive.

5. THREAD SIZE OF HOSE FITTING

The product comes with a metal fitting with Rc thread. Connect the Bushing R thread X NPT thread containing standard accessories. If you would like to have American NPT thread.

6. OPTIONAL PARTS

In addition to standard accessory parts, the following parts are available for your applications and needs.

Part No.	Description	Qty
TA9A005	Saw Blade 32 Ass'y (10pcs)	1
TA9A011	Saw Blade 24 Ass'y (10pcs)	1
TB00193	Saw Blade 18 Ass'y (10pcs)	1
TB00192	Saw Blade 14 Ass'y (10pcs)	1

7. ORDERING SERVICE PARTS

For further operational and handling information or for replacement of parts and components, contact the company from whom you purchased the tool or an authorized dealer.

In ordering parts and components give each part number, part name and quantity required.
Use only NITTO genuine parts.

8. STORAGE

⚠ Caution

When tool is not used, store it out of reach of children.

Avoid storing the tool in a location subject to high humidity. If the tool is left as it is used, residual moisture on the inside can cause rusting. Before storing, and after operation, oil the tool at the air inlet with machine oil ISO VG-10 and run it for a short time.

9. EXPLODED DIAGRAM : SSW-110

Warning

This diagram is for reference only. Do not attempt to service or repair the Tool. Do not take the Tool apart. Contact an authorized Nitto dealer for all service and repair of the Tool.

Improper service and repair can cause accidents and severe injuries.

Never attempt to modify the Tool.

Never attempt to service or repair the Tool yourself.

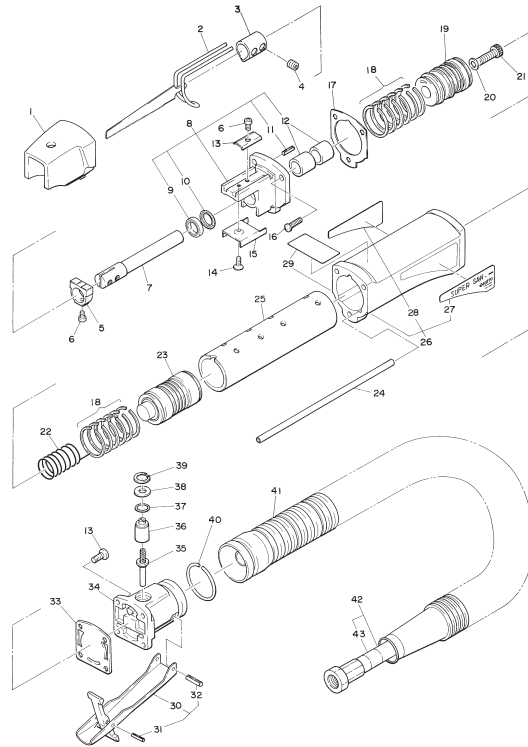

The parts numbers with () are included in the Ass'y parts written above them.

No.	Part No.	Description	Qty	Price
1	TQ01986	Cover	1	
2	TP16638	Supporter	1	
3	TQ02451	Collar 13	1	
4	TP06141	Hex. Socket Set Screw 6x6	2	
5	TQ01969	Guide	1	
6	CP20233	Hex. Socket Head Cap Screw 4x6	2	
7	TQ01968	Guide Shaft	1	
8	TB01654	Cylinder Head Sub Ass'y	1set	
9	(TP03978)	Oil Seal G10x14x3	2	
10	(TA9A101)	U Seal Ass'y	1set	
11	(TP01920)	Spring Pin 3x8 AW	1	
12	(TQ01971)	Bush	2	
13	TQ01992	Supporter Plate	1	
14	TP02902	Cross Recessed Countersunk Flat Head Screw 3x6	1	
15	TQ01972	Guide Holder	1	
16	TP02638	Cross Recessed Pan Head Screw 4x12	7	
17	TQ01985	Packing B	1	
18	TB01653	Piston Ring Ass'y	2set	
19	TQ01982	Piston B	1	
20	LP09810	Plain Washer M5	1	
21	TP01934	Hex. Socket Head Cap Screw 5x18	1	
22	TQ01987	Spring 1x17x42	1	
23	TB01399	Piston A sub Ass'y	1set	
24	TQ01979	Tube	2	
25	TQ01978	Cylinder	1	

No.	Part No.	Description	Qty	Price
26	TB08652	Housing Sub Ass'y	1set	
27	(TQ01976)	Name Plate	1	
28	(TQ12684)	Warning Label	1	
29	(TQ12676)	Label CE Mark	1	
30	TB01388	Throttle Lever Ass'y	1set	
31	(TP05498)	Spring Pin 2x16 AW	1	
32	(TP00460)	Spring Pin 3x22 AW	1	
33	TQ01984	Packing A	1	
34	TQ01974	Valve Body	1	
35	TA93070	Throttle Valve Ass'y	1set	
36	TP06325	Adjust Valve	1	
37	TP11997	O Ring KS-7	1	
38	TP06326	Spacer 6x12x1.2	1	
39	TP03695	Retaining Ring C-12	1	
40	TP09153	Stop Ring O-28.5x2	1	
41	TQ01664	Exhaust Hose	1	
42	TB07658	Air Hose C Ass'y	1set	
43	(TQ11519)	Label Lubrication	1	

Accessories

No.	Part No.	Description	Qty	Price
	TP02236	Bushing R1/4xNPT1/4	1	
		Saw Blade 32	2	
	TP04696	Hex. Socket Screw Key 3	1	
	TQ12693	Instruction Manual	1	
	TQ12773	Declaration of Conformity	1	



Overseas Affiliates / Offices

NITTO KOHKI U.S.A., INC.

46 Chancellor Drive, Roselle, IL 60172 U.S.A.

Tel:(1)-630-924-9393 Fax:(1)-630-924-0303

NITTO KOHKI EUROPE CO., LTD.

Unit 21, The Empire Centre Imperial Way, Watford Herts, WD24 4TS, U.K.

Tel:(44)-1-923-239668 Fax:(44)-1-923-248815

NITTO KOHKI DEUTSCHLAND GMBH

Lerchenstr.47 D-71144 Steinenbronn, Germany

Tel:(49)-7-157-22436 Fax:(49)-7-157-22437

NITTO KOHKI CO., LTD., SINGAPORE BRANCH

10 UBI CRESCENT #01-62, UBI TECHPARK LOBBY D, SINGAPORE 408564,

Tel:(65)-6227-5360 Fax:(65)-6227-0192

NITTO KOHKI AUSTRALIA PTY. LTD.

77 Brandl St., Brisbane Technology Park, Eight Mile Plains QLD 4113 Australia

Tel:(61)-7-3340-4600 Fax:(61)-7-3340-4640

NITTO KOHKI CO., LTD.,

BANGKOK REPRESENTATIVE OFFICE

M&A Business Center 38Q. House Convent Bldg., 7th Floor, Unit 7A, Convent Rd., Silom, Bangrak, Bangkok 10500 Thailand

Tel:(66)-2-632-0307 Fax:(66)-2-632-0308

NITTO KOHKI (SHANGHAI) CO., LTD.

Room1506, suite C, Orient International Plaza, NO85 LouShanGuan Road, Shanghai, 200336, CHINA

Tel:(86)-21-6415-3935 Fax:(86)-21-6472-6957

NITTO KOHKI CO., LTD.,

SHENZHEN REPRESENTATIVE OFFICE

2005C Shenzhen ICC Tower, Fuhuasanlu 168, Futian District, Shenzhen, Guangdong, 518048 China

Tel:(86)-755-8375-2185 Fax:(86)-755-8375-2187



NITTO KOHKI Co., Ltd. 2-9-4, Nakaikegami, Ohta-ku, Tokyo, 146-8555, Japan Tel:(81)-3-3755-1111 Fax(81)-3-3753-8791

EC DECLARATION OF CONFORMITY

We hereby declare that the following our product conforms with the essential health and safety requirements of EU Directives.

Product: PNEUMATIC HACKSAW
Model: SUPER SAW : SSW-110
Serial No: In the case of 6 digits serial number.
XXXXXXXX
Consecutive numbers (00001~99999)
Last digit (0-9) of year (A.D.)
In the case of 7 digits serial number.
XXXXXXXXX
Consecutive numbers (00001~99999)
Last two digits (00-99) of year (A.D.)

Manufacturer: NITTO KOHKI Co., Ltd. 2-9-4, Nakaikegami, Ohta-ku, Tokyo, 146 8555, Japan

Authorised person to prepare the technical construction file(TCF) in the community:

Masatoshi Ogue
President
NITTO KOHKI EUROPE Co., Ltd.
Unit21, Empire Centre, Imperial Way, Watford Hertfordshire,
WD24 4TS, UK
Tel:(44)-01923-239668 Fax:(44)-01923-248815

Directive: 2006/42/EC Machinery Directive

The above product has been evaluated for conformity with above directives using the following European standards. The technical construction file (TCF) for this product is retained at the above manufacturer's location.

Machinery Directive: EN ISO12100:2010, EN ISO11148-12:2012, others
Sound Pressure/Power Level: EN ISO15744:2008, EN ISO4871:1996
Vibration Level: EN28927-8:2009

Signature: K. Kishi

Date/Place: Feb. 18. 2013 Tokyo, Japan

Name: K. Kishi

Title: GENERAL MANAGER MACHINE TOOLS DIV.

NITTO KOHKI Co., Ltd. 2-9-4, Nakaikegami, Ohta-ku, Tokyo, 146-8555, Japan

Being the responsible person appointed and employed the manufacturer.